

LIGHTING QUALITY & HIGH PERFORMANCE

**AMERICAN  
PRO**

THANK YOU  
FOR CHOOSING  
OUR PRODUCTS

# USER MANUAL

**AMERICAN  
PRO**

[www.american-pro.com](http://www.american-pro.com)

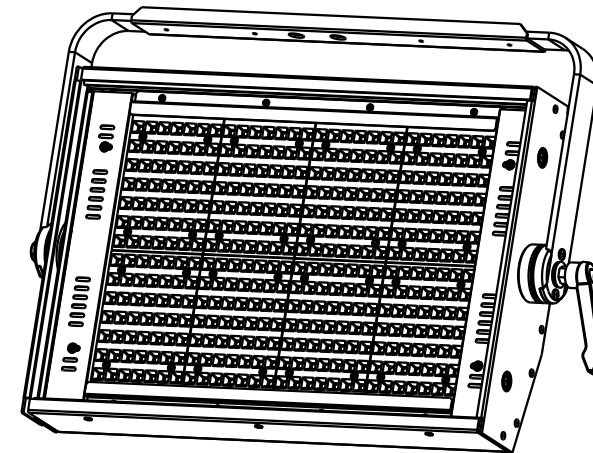

SERIES  
**NEO LED**

**PLANARLED  
3200**

**PLANARLED  
5600**

**AMERICAN  
PRO**

# 1 PRODUCT (GENERAL)

## 1.1 TECHNICAL SPECIFICATIONS

### LED MODULE

LED MODULE:	
Voltage	100~240V...50/60Hz
Rated Power	105W
Environment Temperature	-20℃~40℃
Cooling	Forced air convection
Dimensions	557x372x98mm
Weight	7Kg

## 1.2 SAFETY WARNING

### IMPORTANT

**[ALWAYS READ THE USER MANUAL BEFORE OPERATION. ]**  
**[PLEASE CONFIRM THAT THE POWER SUPPLY STATED ON THE PRODUCT IS THE SAME AS THE MAINS POWER SUPPLY IN YOUR AREA.]**

- This product must be installed by a qualified professional.
- Always operate the equipment as described in the user manual.
- A minimum distance of 0.5m must be maintained between the equipment and combustible surface.
- The product must always be placed in a well ventilated area.
- Always make sure that the equipment is installed securely.
- DO NOT stand close to the equipment and stare directly into the LED light source.
- Always disconnect the power supply before attempting and maintenance.
- Always make sure that the supporting structure is solid and can support the combined weight of the products.
- The earth wire must always be connected to the ground.
- Do not touch the power cables if your hands are wet.

### ATTENTION



- This product left the place of manufacture in perfect condition. In order to maintain this condition and for safe operation, the user must always follow the instructions and safety warnings described in this user manual.
- Avoid shaking or strong impacts to any part of the equipment.
- Make sure that all parts of the equipment are kept clean and free of dust.
- Always make sure that the power connections are connected correct and secure.
- If there is any malfunction of the equipment, contact your distributor immediately.
- When transferring the product, it is advisable to use the original packaging in which the product left the factory.
- Shields, lenses or ultraviolet screens shall be changed if they have become damaged to such an extent that their effectiveness is impaired.
- The lamp (LED) shall be changed if it has become damaged or thermally deformed.

# 5 APPENDIX

## 5.1 MAINTENANCE

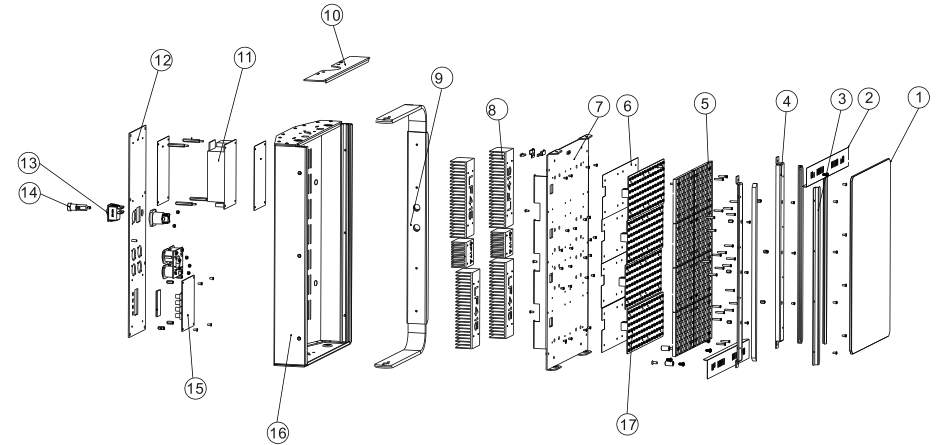

NO	Part name
1	Tempered glass
2	Glass decorative plate A
3	Glass fixed frame B
4	Glass fixed frame A
5	Reflective cup
6	LED isolation sheet
7	LED board fixed board
8	Heat sink A
9	Handrail components
10	Activity side board
11	Power Supply
12	Display board fixed board A
13	Power switch
14	Fuse holder
15	Display board
16	The lamp body of housing
17	LED board

## 4 USING A DMX512 CONTROLLER

### 4.1 BASIC ADDRESSING

- Connect all of the units in series using standard DMX512 signal cable provided.
- Set the DMX512 address in the **【DMX】** menu.
- It is possible to have the same DMX address or independent addresses for each fixture.

### 4.2 CHANNEL ASSIGNMENT

**【Std.w】**, **【UNO】**.

#### Std.w

CHANNEL	VALUE	FUNCTION
1	0 ↔ 255	WARM WHITE
2	0 ↔ 255	COOL WHITE

#### UNO

CHANNEL	VALUE	FUNCTION
1	0 ↔ 255	Dimmer

## 2 INSTALLATION

### 2.1 MOUNTING

#### UPRIGHT

The LED MODULE can be fix-mounted in an upright or sitting position using the supporting brackets.

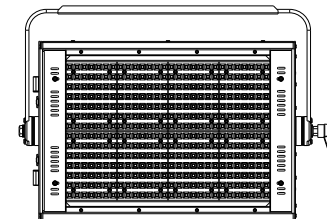

#### HANGING

The LED MODULE can be mounted in a hanging position using the support frame. It is possible to use any bolt of the correct size and strength to mount the fixture. It is recommended to use at least 2 mounting points per fixture. Mounting with a clamp or other mounting bracket is recommended depending on the requirements of your application. For overhead use, always install two secure-chains that can hold at least 10 times the weight of the fixture.

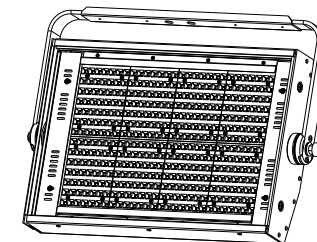

### 2.2 POWER CONNECTIONS

**Note:** If over 30 units to be connected, then a DMX signal amplifier is needed.

### 2.3 SETTING UP WITH A DMX512 CONTROLLER

- Connect the DMX512 controller to the units in series.
- Each DMX Address may be used as many times as required.
- Any DMX address in the range from 001 to 512 may be used.

### 3 DISPLAY PANEL OPERATION

#### 3.1 BASIC

- 【MENU】 scroll through the main menu or return to the main menu
- 【ENTER】 enter the currently selected menu or confirm the current function value
- 【UP】 scroll 'UP' through the menu list or increase the value of the current function
- 【DOWN】 scroll 'DOWN' through the menu list or decrease the value of the current function

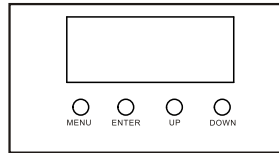

#### 3.2 MENU

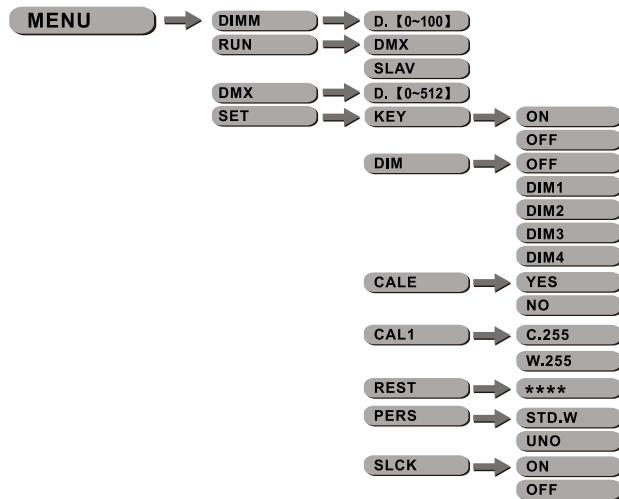

#### 3.3 DIMMER MODE



- Enter the 【DIMM】 to set dimmer value.
- Press 【UP】 / 【DOWN】 to adjust value.

#### 3.4 RUN MODE



- Enter the 【RUN MODE】 mode to set operation mode.
- 【DMX】 mode is for using the DMX512 controller to control the fixtures.
- 【SLAVE】 mode is for Master -- Slave operation.

#### 3.5 DMX ADDRESS



- Enter the 【DMX ADDRESS】 mode to set the DMX ADDRESS.

#### 3.6 SPECIAL SETTINGS

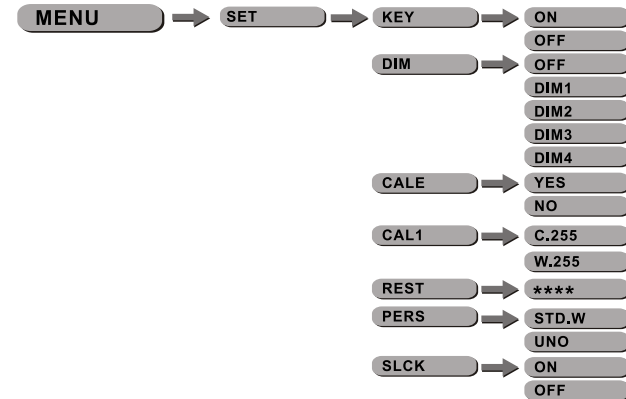

- Enter 【KEY】 menu to select whether the KEY-LOCK is ON/OFF.
- 【DIM】 mode allows user to select specific dimming curve.
- Enter the 【CALE】 mode to allow fixture calibration.
- 【CAL1】 allows calibration of color temperature for UNO DMX control personality.
- 【REST】 enables user to reset all values.
- 【PERS】 enables user to select DMX control personality.
- 【SLCK】 When the menu is the 【SET】 ,we can setup menu protection setting, select ON, reopen. 【SET】 setup menu to enter a password, select the OFF can be directly opened.